

Puerta PORTALS

FUTUR^{BATH}

INSTRUCCIONES DE MONTAJE

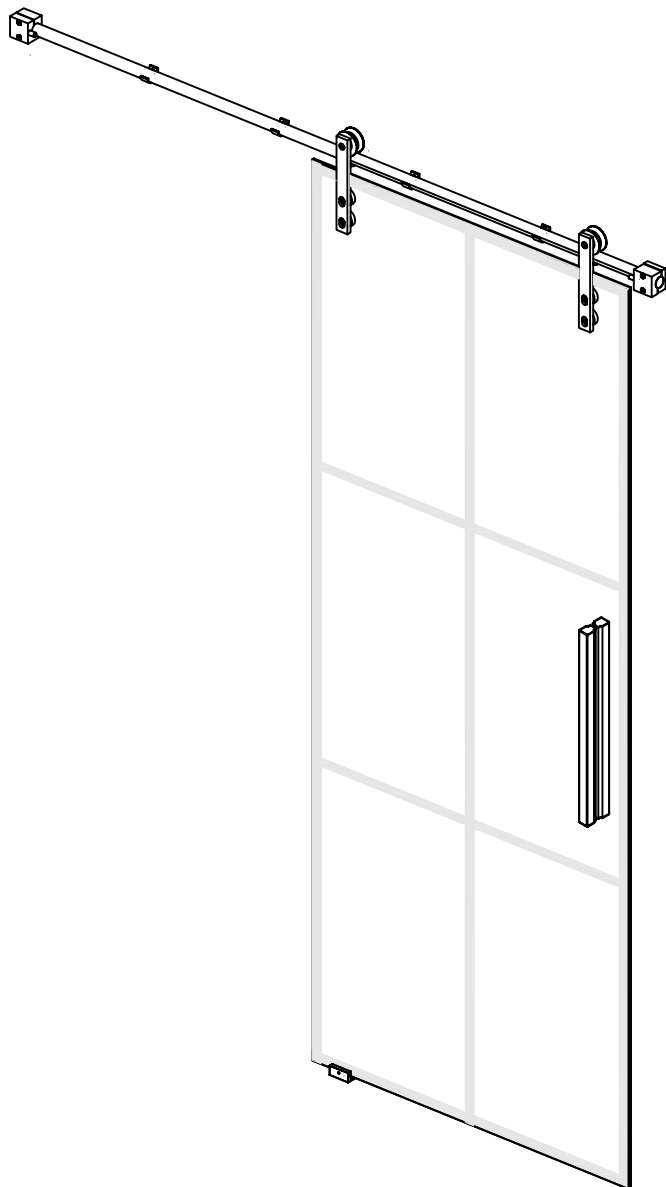

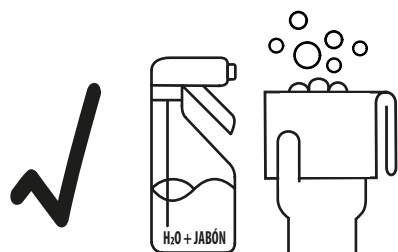
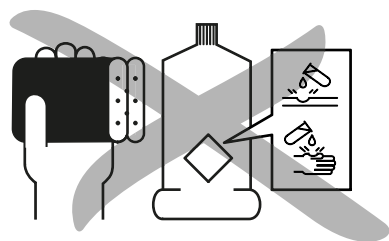

NOTA IMPORTANTE_ LIMPIEZA DE LA PUERTA

Limpié su puerta siempre con jabones neutros y agua.
Otro tipo de productos pueden dañar serigrafías, gomas de estanqueidad, perfiles e incluso los tratamientos anticorrosivos de los cristales en caso de llevarlos.
Limpiar siempre las piezas metálicas con un paño suave, no utilizar estropajos, provocaría arañazos.

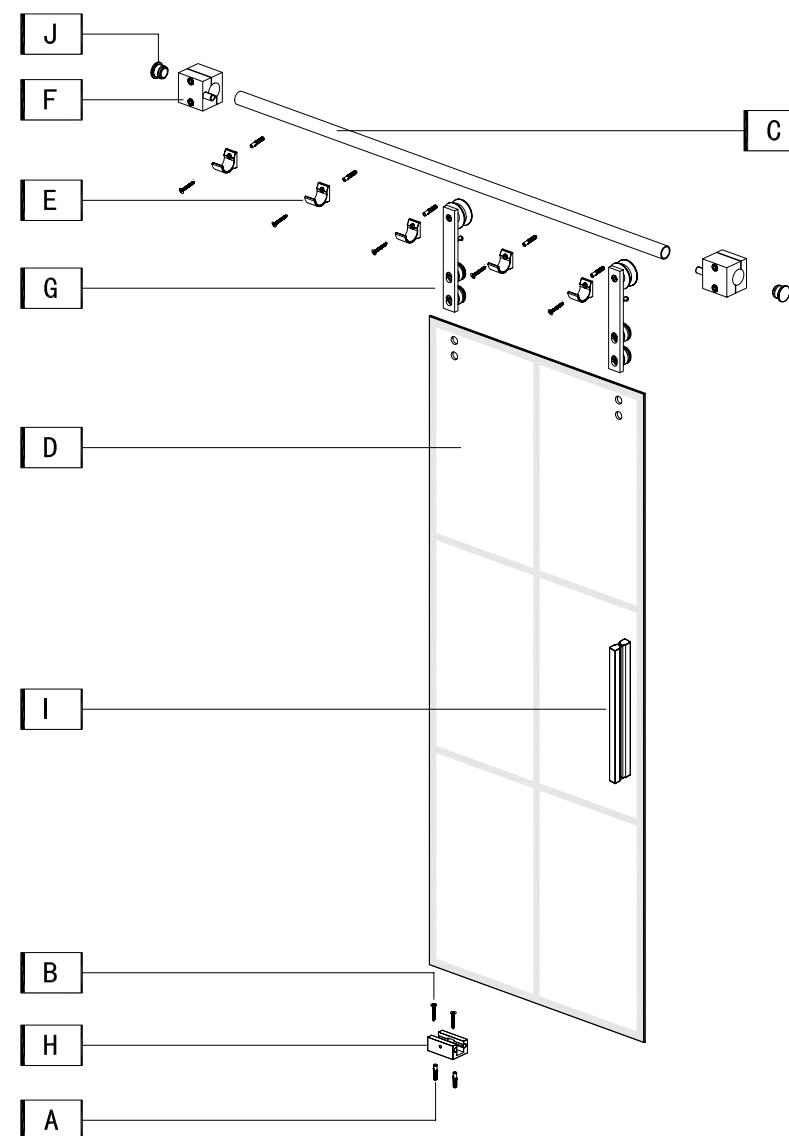

MONTAJE

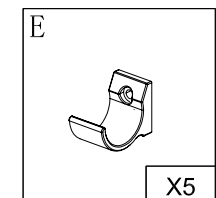
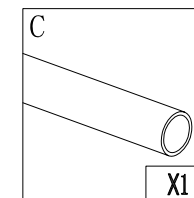
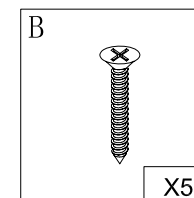
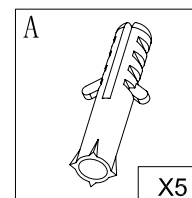
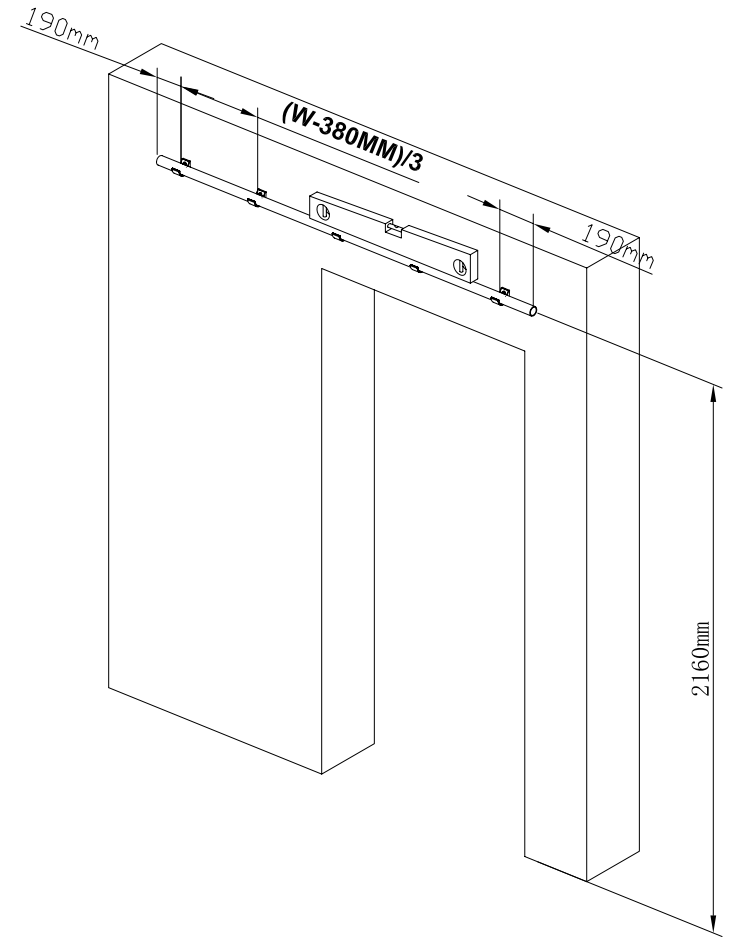
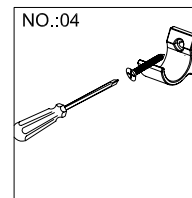
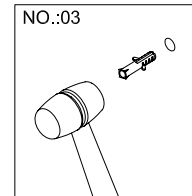
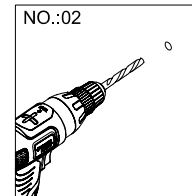
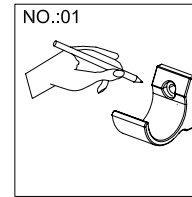
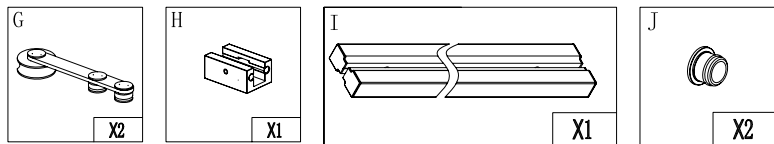
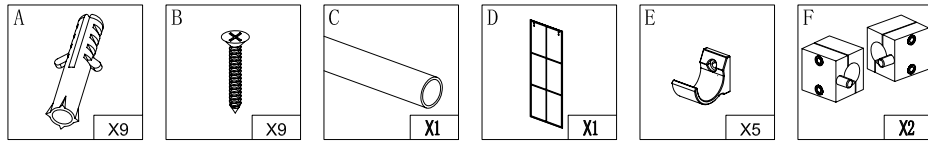
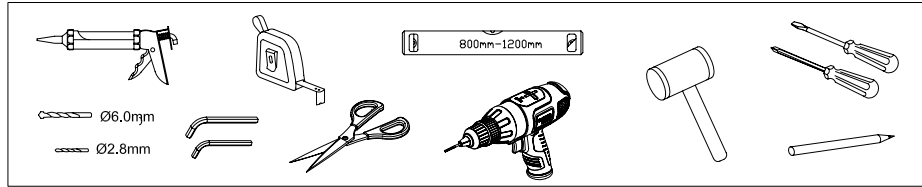

MONTAJE

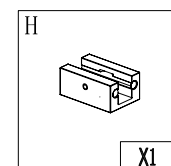
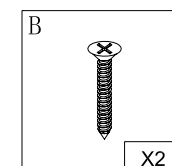
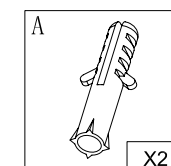
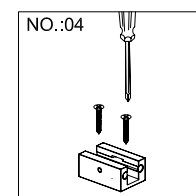
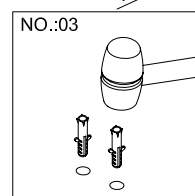
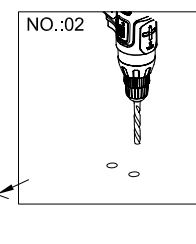
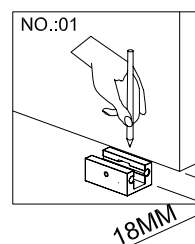
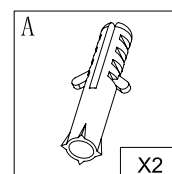
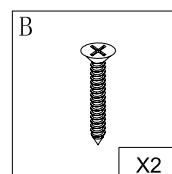
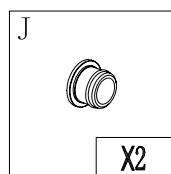
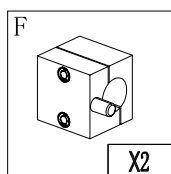
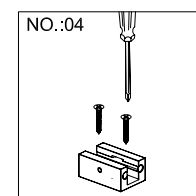
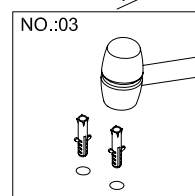
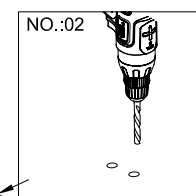
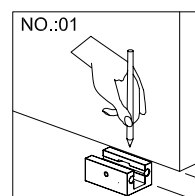
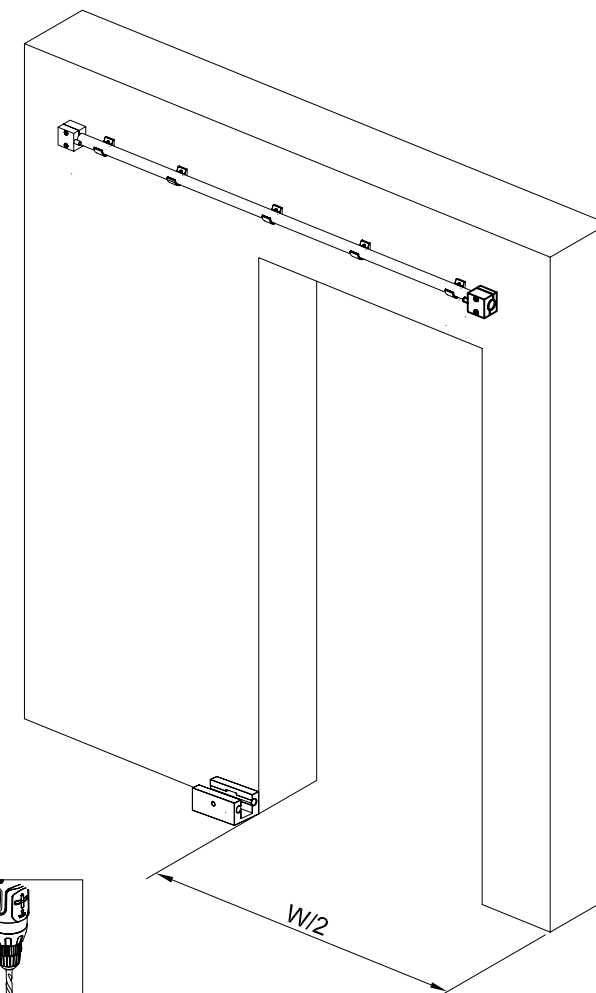
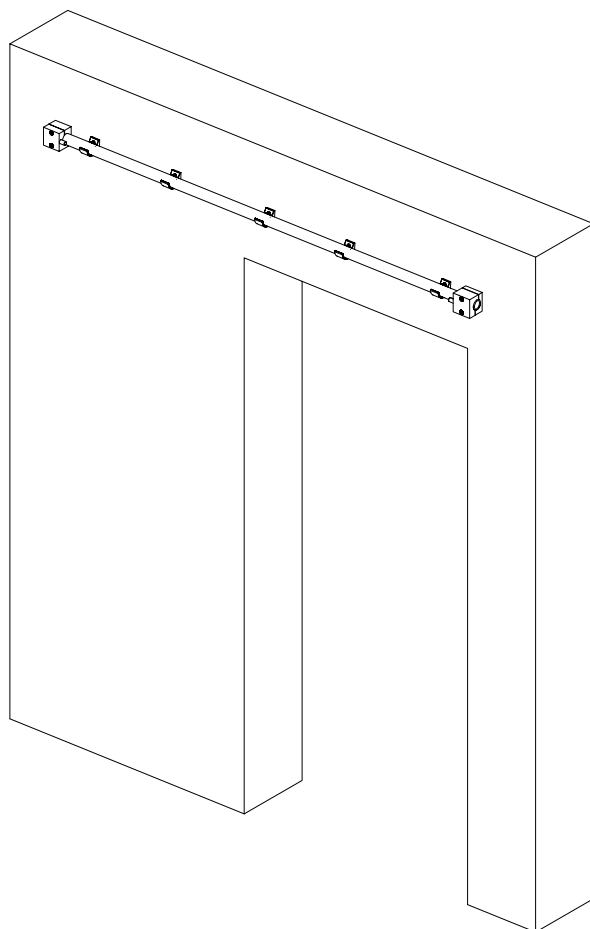
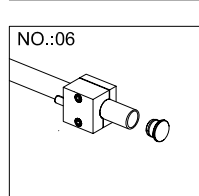
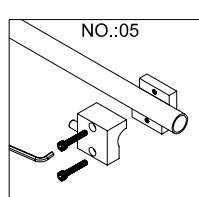
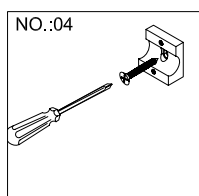
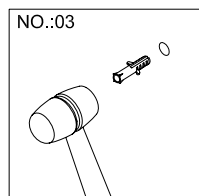
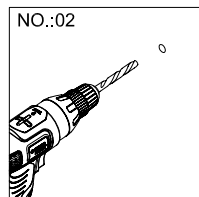
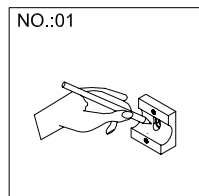

MONTAJE

